

### Features

- Max Junction Temperature 150°C
- High breakdown voltage up to 650V for improved reliability
- Short Circuit Rated
- Very Low Saturation Voltage:  
 $V_{CE(SAT)} = 1.65V$  (Typ.) @  $I_C = 15A$
- Soft current turn-off waveforms

$V_{CE}$	<b>650</b>	<b>V</b>
$I_C$	<b>15</b>	<b>A</b>
$V_{CE(SAT)} I_C=15A$	<b>1.65</b>	<b>V</b>

### Applications

- Soft switching applications
- Air conditioning
- Motor drive inverter

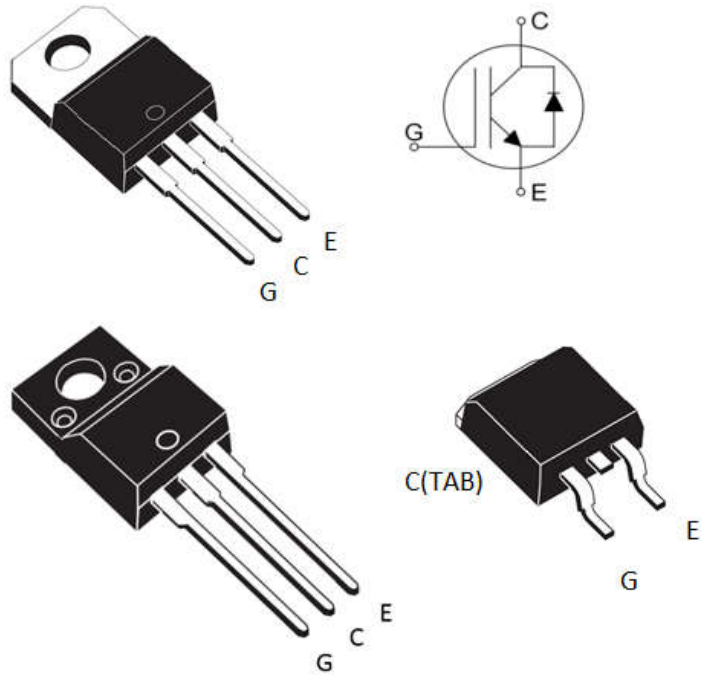

Product	Package	Packaging
YGP15N65T1	TO-220	Tube
YGK15N65T1	TO-263	Tube
YGF15N65T1	TO-220F	Tube

**Maximum Ratings** ( $T_j = 25^\circ\text{C}$  unless otherwise specified)

Parameter	Symbol	Value	Unit
Collector-Emitter Breakdown Voltage	$V_{CE}$	650	V
DC collector current, limited by $T_{jmax}$ $T_C = 25^\circ\text{C}$ $T_C = 100^\circ\text{C}$	$I_C$	30 15	A
Diode Forward current, limited by $T_{jmax}$ $T_C = 25^\circ\text{C}$ $T_C = 100^\circ\text{C}$	$I_F$	30 15	A
Continuous Gate-emitter voltage	$V_{GE}$	$\pm 20$	V
Transient Gate-emitter voltage	$V_{GE}$	$\pm 30$	V
Turn off safe operating area $V_{CE} \leq 650\text{V}$ , $T_j \leq 150^\circ\text{C}$	-	60	A
Pulsed collector current, $V_{GE} = 15\text{V}$ , $t_p$ limited by $T_{jmax}$	$I_{CM}$	45	A
Short Circuit Withstand Time, $V_{GE} = 15\text{V}$ , $V_{CE} \leq 400\text{V}$	$T_{sc}$	5	$\mu\text{s}$
TO-220F Power dissipation, $T_j = 25^\circ\text{C}$	$P_{tot}$	27	W
TO-220, TO-263, Power dissipation, $T_j = 25^\circ\text{C}$	$P_{tot}$	105	W
Operating junction temperature	$T_j$	-40...+150	$^\circ\text{C}$
Storage temperature	$T_s$	-55...+150	$^\circ\text{C}$
Soldering temperature, wave soldering 1.6mm (0.063in.) from case for 10s	-	260	$^\circ\text{C}$

**Thermal Resistance**

Parameter	Symbol	TO-220, TO-263	TO-220F	Unit
IGBT thermal resistance, junction - case	$R_{\theta(j-c)}$	1.2	4.9	K/W
Diode thermal resistance, junction - case	$R_{\theta(j-c)}$	2.38	5.8	K/W
Thermal resistance, junction - ambient	$R_{\theta(j-a)}$	62.5		K/W

**Electrical Characteristics of the IGBT** ( $T_j = 25^\circ\text{C}$  unless otherwise specified)

Symbol	Parameter	Test Conditions	Min.	Typ.	Max.	Units
<b>Static Characteristics</b> (Tested on wafers)						
$BV_{CES}$	Collector to Emitter Breakdown Voltage	$V_{GE} = 0V, I_C = 1mA$	650	-	-	V
$V_{CE(SAT)}$	Collector to Emitter Saturation Voltage	$I_C = 15A, V_{GE} = 15V$	-	1.65	1.95	V
$V_{GE(th)}$	G-E Threshold Voltage	$V_{GE} = V_{CE}, I_C = 250\mu A$	4.1	5.0	5.7	V
$I_{CES}$	Collector Cut-Off Current	$V_{CE} = 650V, V_{GE} = 0V$	-	-	25	$\mu A$
$I_{GES}$	G-E Leakage Current	$V_{GE} = \pm 20V, V_{CE} = 0V$	-	-	$\pm 200$	nA
$g_{fs}$	Transconductance	$V_{CE}=20V, I_C=15A$	-	10	-	S

Parameter	Symbol	Conditions	Min	Typ	Max	Unit
<b>Dynamic</b>						
Input capacitance	$C_{ies}$	$V_{CE} = 25V, V_{GE} = 0V,$ $f = 1MHz$	-	990	-	pF
Output capacitance	$C_{oes}$		-	56	-	
Reverse transfer capacitance	$C_{res}$		-	30	-	
Gate charge	$Q_G$	$V_{CC} = 480V, I_C = 15A,$ $V_{GE} = 15V$	-	52	-	nC
Short circuit collector current	$I_{C(SC)}$	$V_{GE}=15V, t_{SC} \leq 5\mu s$ $V_{CC}=400V,$ $T_{j, start}=25^\circ C$	-	98	-	A

**Switching Characteristic, Inductive Load** ( $T_j = 25^\circ\text{C}$  unless otherwise specified)

Parameter	Symbol	Conditions	Min.	Typ.	Max.	Unit
<b>Dynamic</b>						
Turn-on Delay Time	$t_{d(on)}$	$T_j = 25^\circ\text{C}$ $V_{CC} = 400\text{V}$ , $I_C = 15\text{A}$ , $V_{GE} = 0/15\text{V}$ , $R_g = 12\Omega$	-	15	-	ns
Rise Time	$t_r$		-	25	-	ns
Turn-off Delay Time	$t_{d(off)}$		-	60	-	ns
Fall Time	$t_f$		-	46	-	ns
Turn-on Energy	$E_{on}$		-	0.75	-	mJ
Turn-off Energy	$E_{off}$		-	0.1	-	mJ

**Electrical Characteristics of the DIODE** ( $T_j = 25^\circ\text{C}$  unless otherwise specified)

Parameter	Symbol	Conditions	Min	Typ	Max	Unit
<b>Dynamic</b>						
Diode Forward Voltage	$V_{FM}$	$I_F = 15\text{A}$	-	1.7	-	V
Reverse Recovery Time	$T_{rr}$	$I_F = 15\text{A}$ $V_R = 300\text{V}$ , $di/dt = 200\text{A}/\mu\text{s}$	-	50	-	ns
Reverse Recovery Current	$I_{rr}$		-	4	-	A
Reverse Recovery Charge	$Q_{rr}$		-	83	-	nC

Fig. 1 FBSOA characteristics for TO-220F

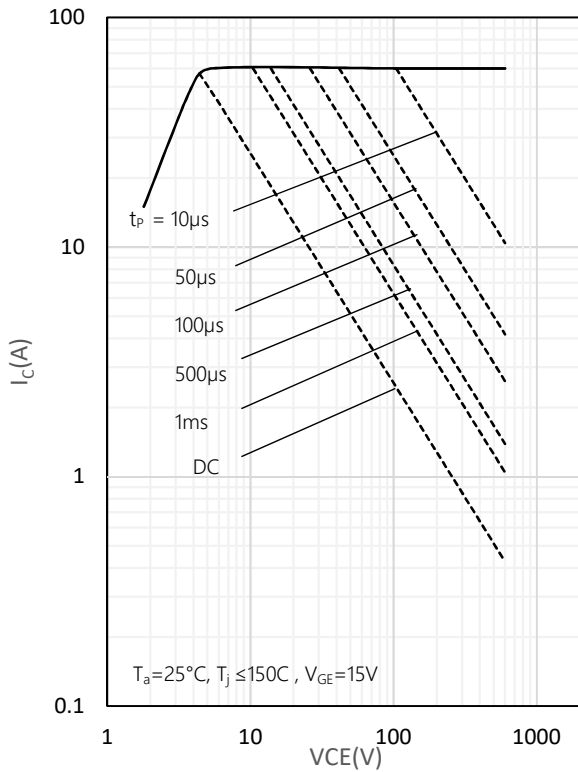

Fig. 2 FBSOA characteristics for TO-220 and TO-263

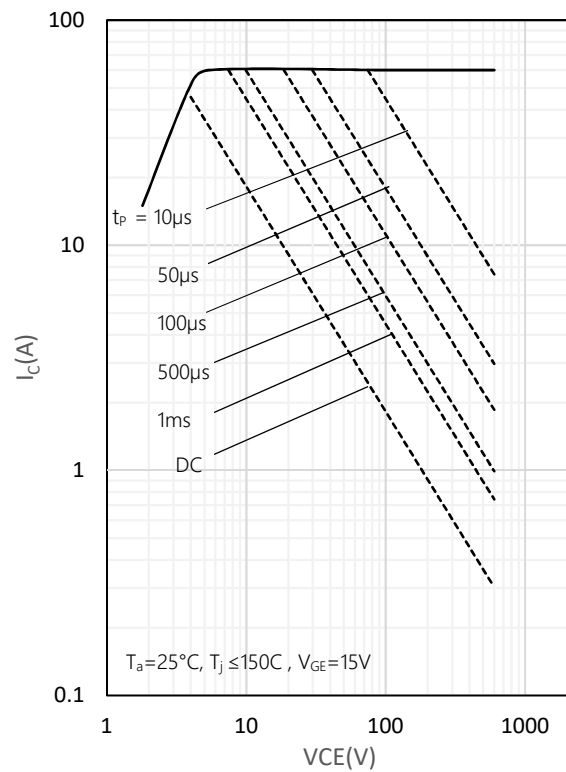

Fig. 3 Load Current vs. Frequency for TO-220F

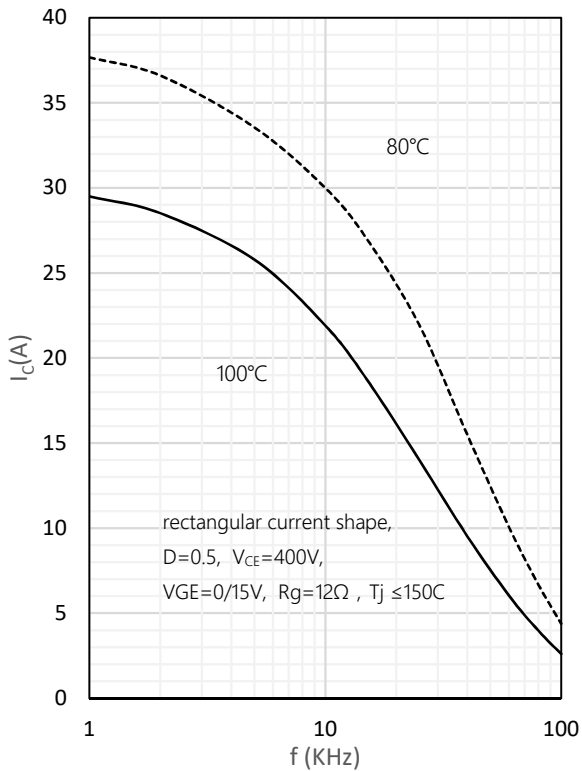

Fig.4 Load Current vs. Frequency TO-220 and TO-263

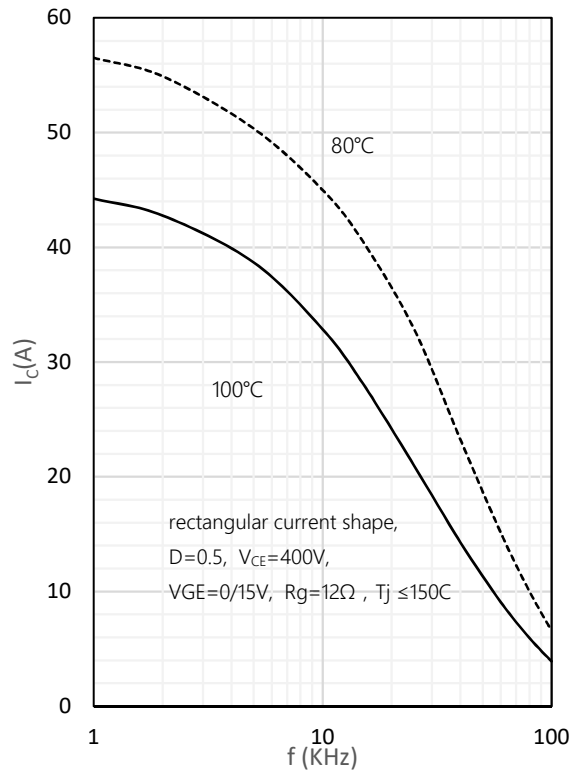

Fig. 5 Output characteristics

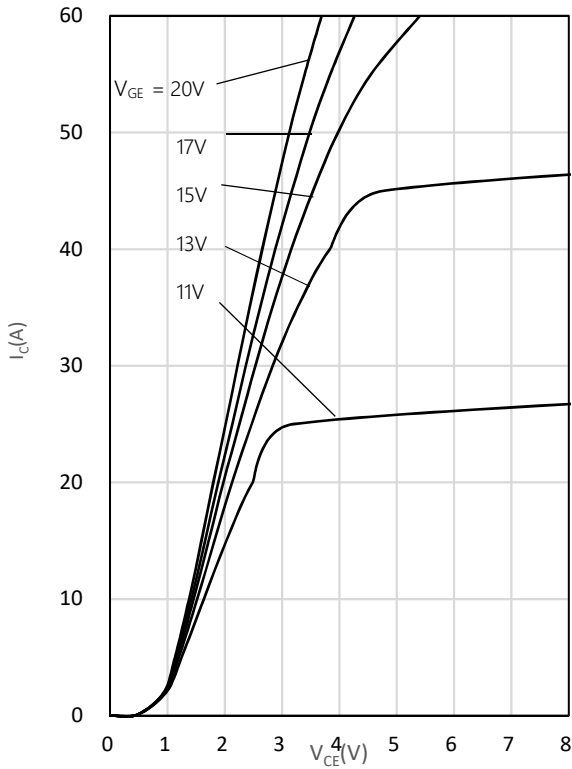

Fig. 6 Saturation voltage characteristics

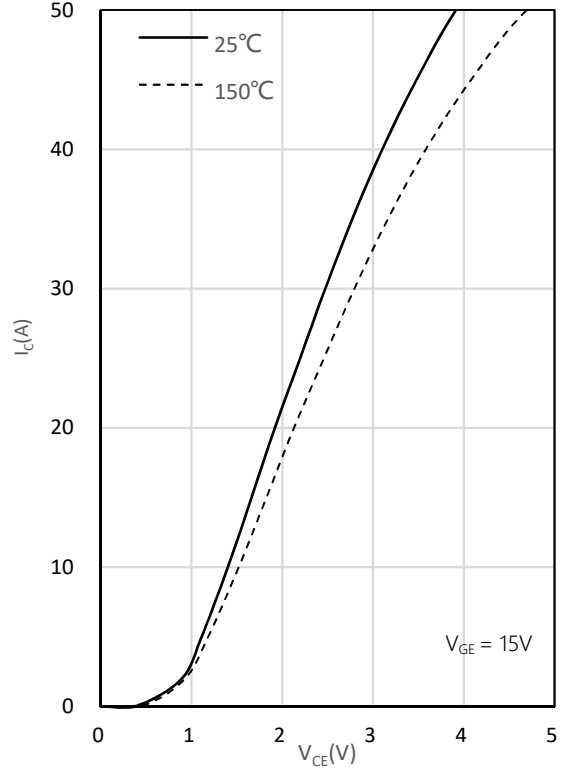

Fig. 7 Switching times vs. gate resistor

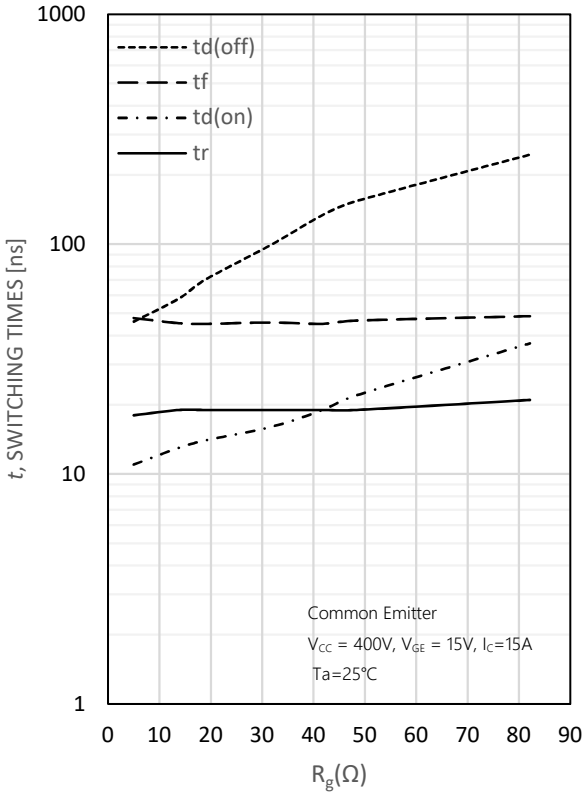

Fig. 8 Switching times vs. collector current

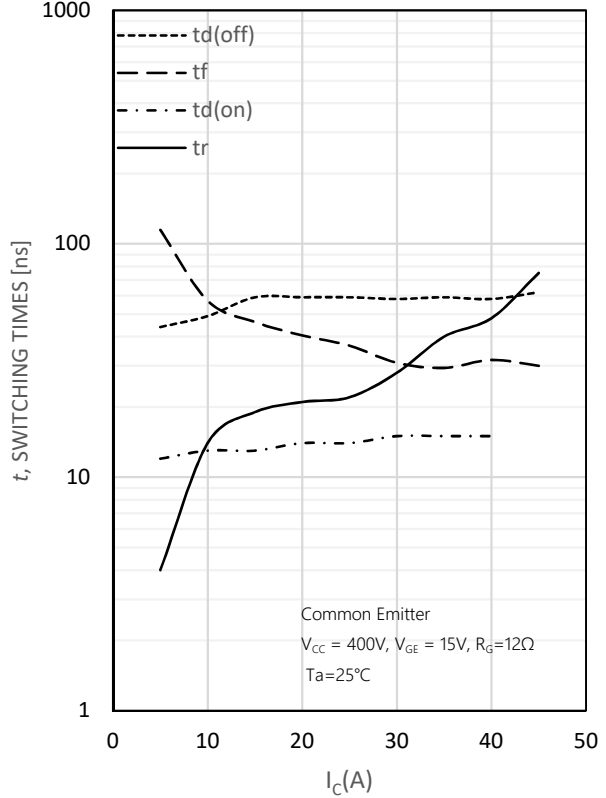

Fig. 9 Switching loss vs. gate resistor

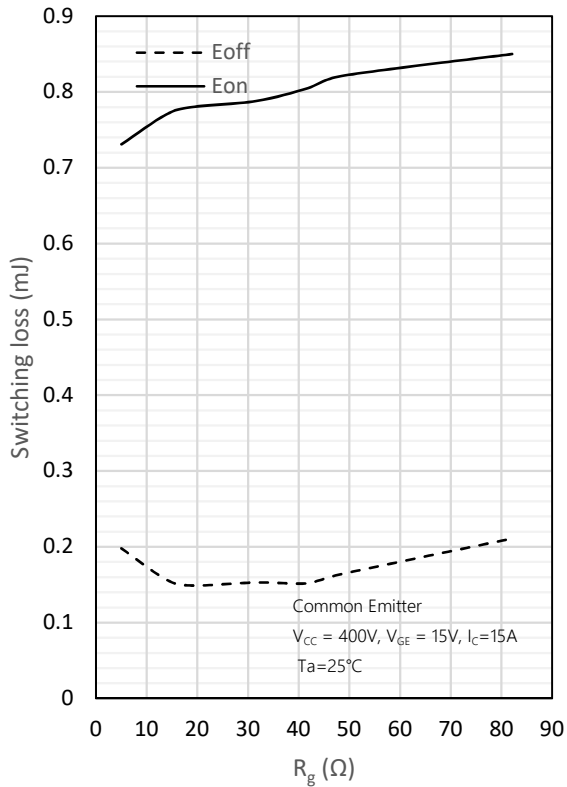

Fig. 10 Switching loss vs. collector current

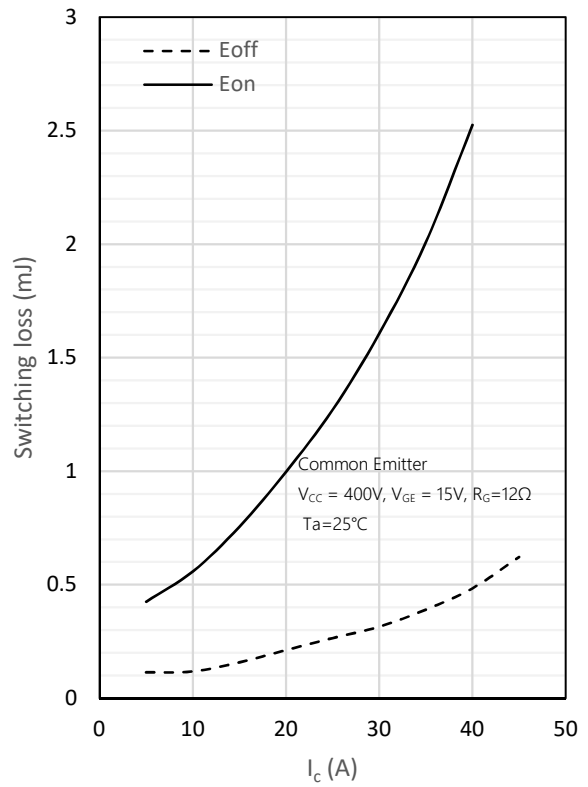

Fig. 11 Gate charge characteristics

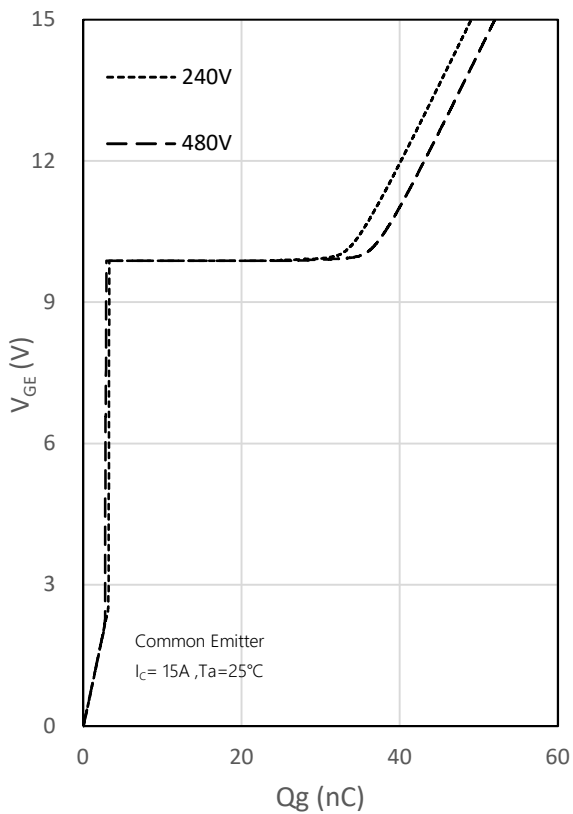
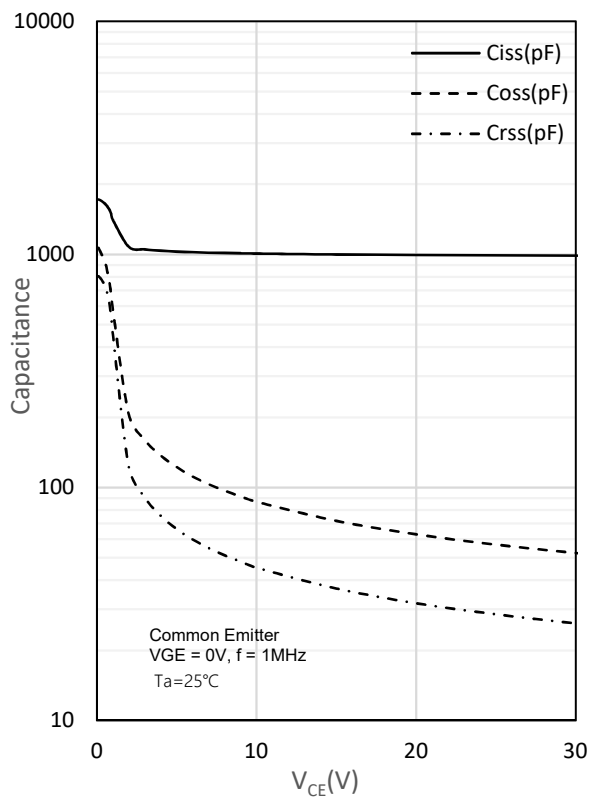
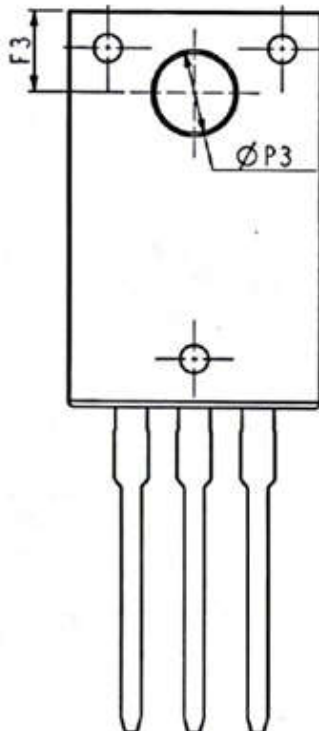
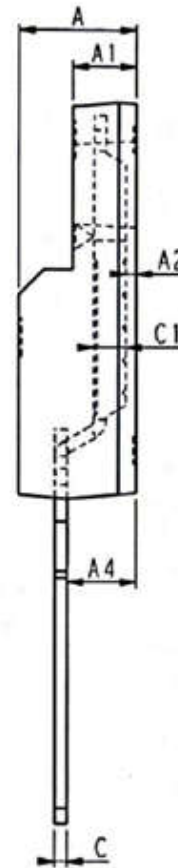
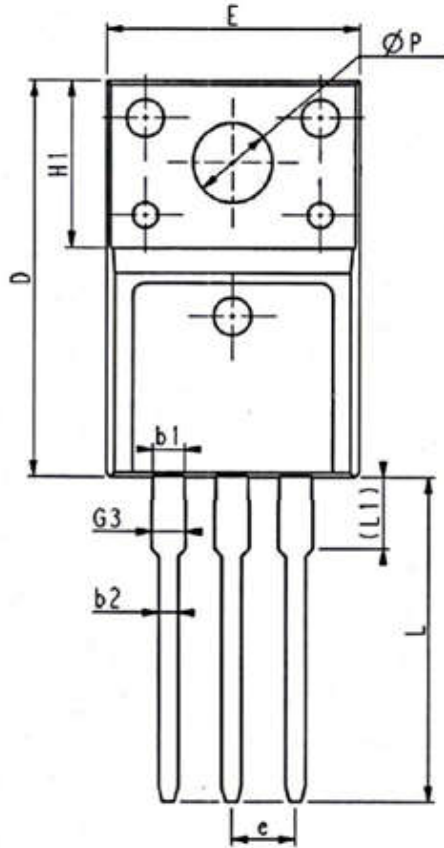

Fig. 12 Capacitance characteristics



**TO-220F package information**



SYMBOL			
	MIN	NOM	MAX
E	9.96	10.16	10.36
A	4.50	4.70	4.90
A1	2.34	2.54	2.74
A2	0.30	0.45	0.60
A4	2.56	2.76	2.96
c	0.40	0.50	0.65
c1	1.20	1.30	1.35
D	15.57	15.87	16.17
H1	6.70REF		
e	2.54BSC		
L	12.68	12.98	13.28
L1	2.88	3.03	3.18
ØP	3.03	3.18	3.38
ØP3	3.15	3.45	3.65
F3	3.15	3.30	3.45
G3	1.25	1.35	1.55
b1	1.18	1.28	1.43
b2	0.70	0.80	0.95



**TO-263 package information**

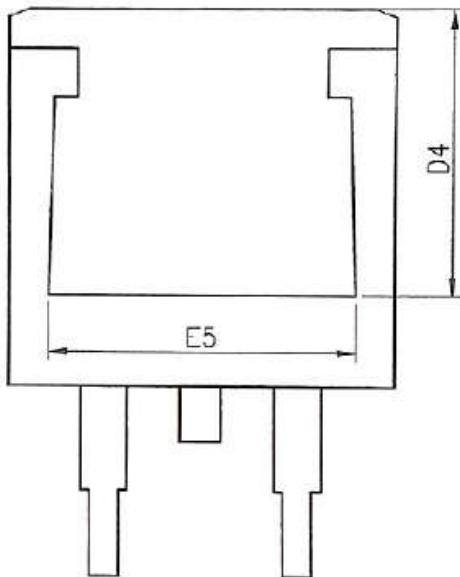
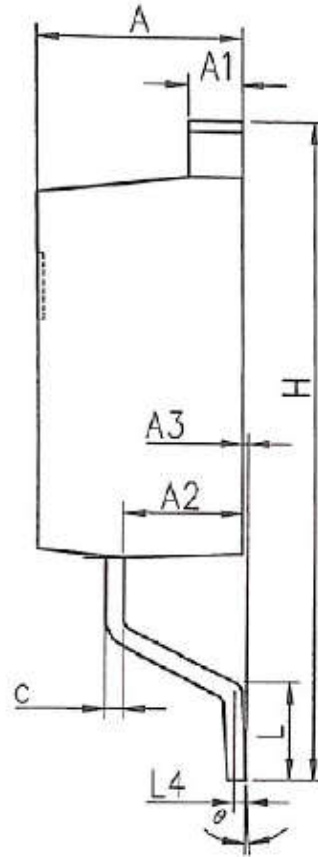
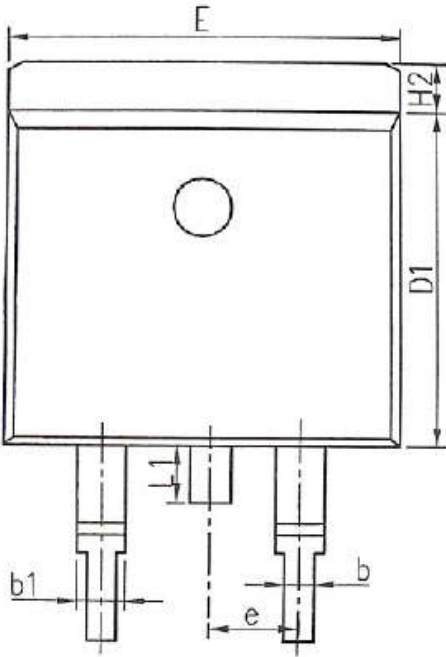

SYMBOL	MM		
	MIN	NOM	MAX
A	4.37	4.57	4.77
A1	1.22	1.27	1.42
A2	2.49	2.69	2.89
A3	0.00	0.13	0.25
b	0.70	0.81	0.96
b1	1.17	1.27	1.47
c	0.30	0.38	0.53
D1	8.50	8.70	8.90
D4	6.60	-	-
E	9.88	10.16	10.36
E5	7.06	-	-
e	2.54 BSC		
H	14.70	15.10	15.50
H2	1.07	1.27	1.47
L	2.00	2.30	2.60
L1	1.40	1.55	1.70
L4	0.25 BSC		
$\theta$	0°	5°	9°

### TO-220 package information

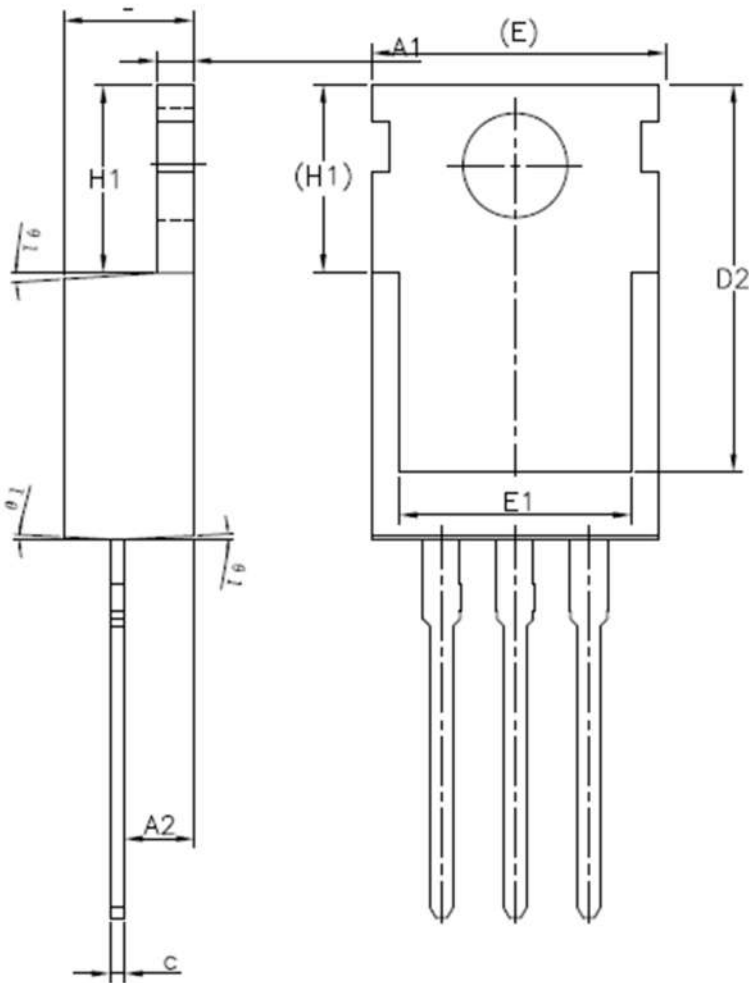

SYMBOL	MIN	NOM	MAX
A	4.40	4.50	4.60
A1	1.27	1.30	1.33
A2	2.30	2.40	2.50
b	0.70	—	0.90
b1	1.27	—	1.40
c	0.45	0.50	0.60
D	15.30	15.70	16.10
D1	9.10	9.20	9.30
D2	13.10	—	13.70
E	9.70	9.90	10.20
E1	7.80	8.00	8.20
e	2.54BSC		
e1	5.08BSC		
H1	6.30	6.50	6.70
L	12.78	13.08	13.38
L1	—	—	3.50
L2	4.60REF		
$\phi P$	3.55	3.60	3.65
Q	2.73	—	2.87
$\theta 1$	1°	3°	5°

